

FICHE D'HOMOLOGATION / HOMOLOGATION FORM



050-TP-72



COMMISSION
INTERNATIONALE
DE KARTING - FIA

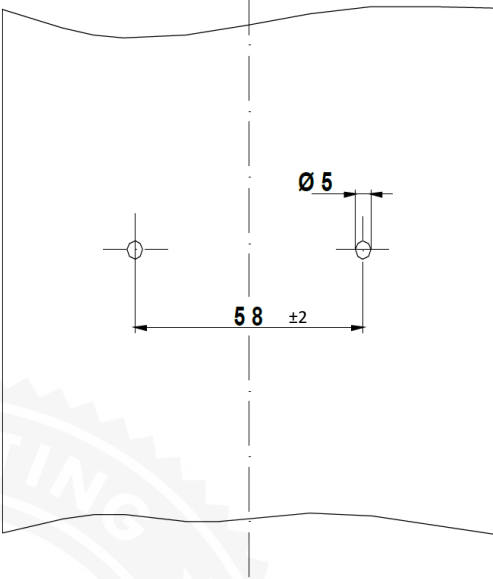

PNEUMATIQUE / TYRE 5" SLICK PRIME

Manufacturier / <i>Manufacturer</i>	Reifenwerk Heidenau GmbH&Co.KG
Marque / <i>Make</i>	MOJO
Modèle / <i>Model</i>	D5 4.5/10.0-5
Catégorie / <i>Category</i>	Groups 1 & 2
Durée de l'homologation / <i>Validity of the homologation</i>	3 ans / 3 years
Nombre de pages / <i>Number of pages</i>	4
La présente Fiche d'Homologation reproduit descriptions, illustrations et dimensions du pneumatique au moment de l'homologation CIK-FIA et du test d'homologation.	<i>This Homologation Form reproduces descriptions, illustrations and dimensions of the tyre at the moment of the CIK-FIA homologation and of the homologation test.</i>
	
Photo du pneu monté sur la jante / <i>Photo of the tyre fitted to the rim</i>	Dessin de la bande de roulement / <i>Tread design drawing</i>
SIGNATURE ET TAMPON DE L'ASN / SIGNATURE AND STAMP OF THE ASN	SIGNATURE ET TAMPON DE LA CIK-FIA / SIGNATURE AND STAMP OF THE CIK-FIA
	

DESCRIPTIONS TECHNIQUES	TECHNICAL DESCRIPTIONS
Sous une température de 23°C +/-2°C, avec une humidité de 50% +/-5%	At a temperature of 23°C +/-2°C and with a humidity of 50% +/-5%

Pt	Descriptions / Descriptions	Valeurs / Values		Tolérances / Tolerances	
1	Dimensions / <i>Dimensions</i>	4.5/10.0-5		--	
2	Désignation du mélange / <i>Tread compound designation</i>	D5		--	
3	Pression de service / <i>Service pressure</i>	0.6 bar		+/- 0.3 bar	
4	Pression de gonflage / <i>Inflation pressure</i>	4.0 bar		max	
5	Capacité de charge / <i>Load capacity</i>	80 kg		max	
6	Vitesse maximale / <i>Maximum speed</i>	180 km/h			
7	Rigidité latérale et verticale (sous charge de 40 kg) / <i>Lateral and vertical stiffness (under 40 kg load)</i>	V: 1.0 mm L: 13.0 mm		L: +/-1 V: +/-2	
8					
9	Profondeur du profil / <i>Depth of tread</i>	3.5 mm		+/- 0.5 mm	
10	Poids en grammes / <i>Weight in grams</i>	1190		+/- 10%	
11	Nombre de plis / <i>Number of plies</i>	2		--	
12	Épaisseur de la bande de roulement / <i>Tread thickness</i>	4.5 mm		+/- 1.0 mm	
13	Nombre d'indicateurs d'usure du pneu / <i>Number of tread wear indicators</i>	8		--	
14	Matériau de la carcasse / <i>Carcass material</i>	Polyester		--	
15	Angle de tissage de la toile du pneu / <i>Angle of tyre canvas</i>	30°		+/- 3°	
16	Type de fil de tissage (selon ISO) / <i>Canvas thread type (according to ISO)</i>	1100		--	
17	Pneu tubeless / <i>Tubeless tyre</i>	Yes		--	
18	Dureté superficielle de la bande de roulement (ISO 48:1010 – 2 échantillons de 2 mm d'épaisseur) / <i>Superficial tread hardness (ISO 48:1010 – 2 samples of 2 mm thickness)</i>	37.5		+/- 5 DIDC - IRHD	
19	Contrainte-déformation en traction (ISO 37:2017 – éprouvette type 3) / <i>Tensile stress-strain (ISO 37:2017 – type 3 sample)</i>	à / at 100%	à / at 300%	à / at 100%	à / at 300%
		1.2	6.5	+/- 0.5 MPa	+/- 0.8 MPa

DESSIN

DRAWING

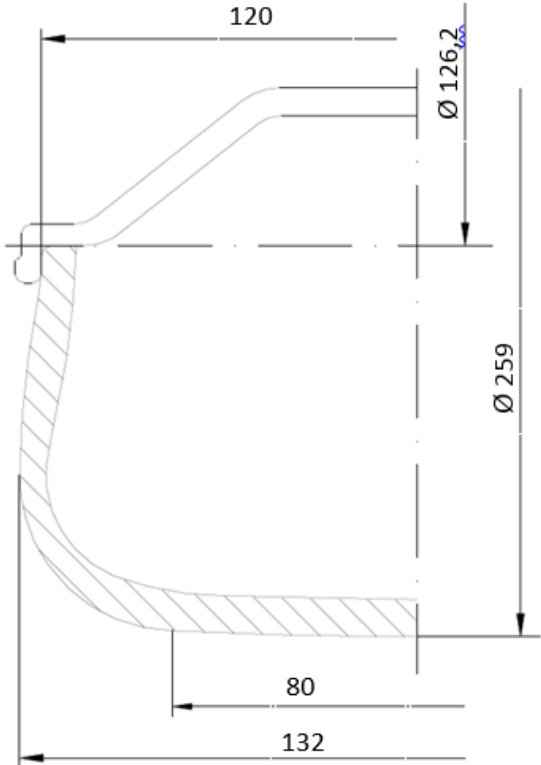
Dessin du pneu en section transversale et dimensions du pneu monté sur une jante / <i>Drawing of tyre cross section and dimensions of the tyre fitted to a rim</i>	Dimensions / <i>Dimensions</i>	Tolérances / <i>Tolerances</i>
	Ø 259 mm	+/- 5.0 mm
	Ø 126.2 *	+0/-1.0
	132 mm	+/- 3.0 mm
	80 mm	+/- 3.0 mm
	120 mm	+/- 2.0 mm
<p>*Dimension selon Dessin Technique N° 1.1 - Jante 5" / <i>Dimension according to Technical Drawing N° 1.1 - 5" rim</i></p>		

DESSIN TECHNIQUE N° 1.1 / TECHNICAL DRAWING No. 1.1

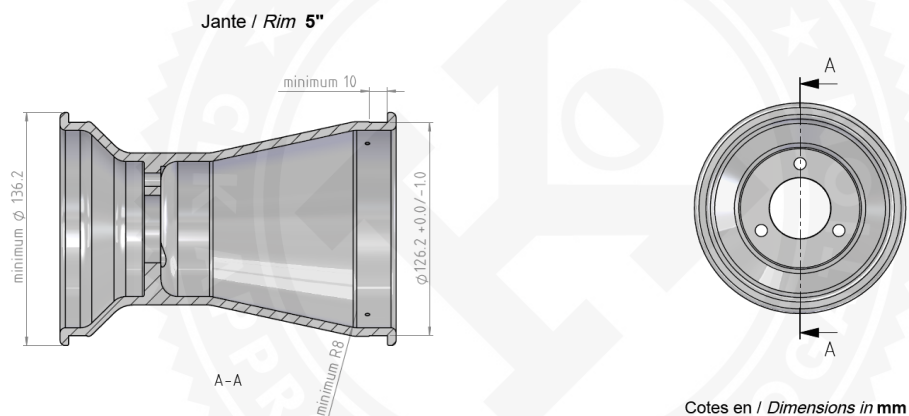

PHOTOS ET INSCRIPTIONS**PHOTOS AND INSCRIPTIONS**

Pendant toute la période d'homologation, il est interdit d'apposer des inscriptions autres que celles mentionnées ci-dessous et appliquées lors de la production.

Throughout the homologation period, it is forbidden to affix markings other than those mentioned below and applied at the time of production.

Photo du flanc extérieur du pneu /
Photo of tyre external sidewall

Inscriptions sur le flanc extérieur du pneu /
Inscriptions on tyre external sidewall





Texte / Text	Hauteur / Height	Trait / Stroke
MOJO (printed)	11 mm	2.5 mm
4.5/10.0 – 5	7 mm	2.0 mm
TUBELESS	4 mm	0.5 mm
MADE IN GERMANY	3 mm	0.5 mm
	8 mm	
FOR RACING PURPOSE ONLY	4 mm	0.5 mm
MAX. INFLATION PRESSURE 4.0 BAR/ 58 PSI	4 mm	0.5 mm

Photo du flanc intérieur du pneu /
Photo of tyre internal sidewall

Inscriptions sur le flanc intérieur du pneu /
Inscriptions on tyre internal sidewall



Texte / Text	Hauteur / Height	Trait / Stroke
MOJO	16 mm	5.0 mm
4.5/10.0 – 5	7 mm	2.0 mm
TUBELESS	4 mm	0.5 mm
MADE IN GERMANY	3 mm	0.5 mm
D5	5 mm	0.5 mm
	8 mm	
FOR RACING PURPOSE ONLY	4 mm	0.5 mm
MAX. INFLATION PRESSURE 4.0BAR/ 58 PSI	4 mm	0.5 mm
CIK	6 mm	2.0 mm
Prime	5 mm	0.5 mm