

# FICHE D'HOMOLOGATION / HOMOLOGATION FORM



050-TO-52



COMMISSION  
INTERNATIONALE  
DE KARTING - FIA

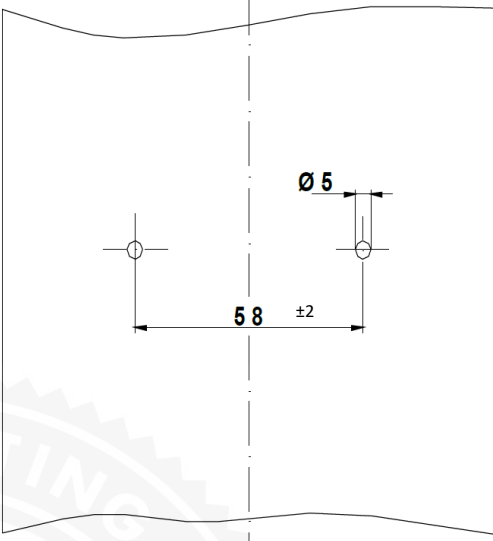

## PNEUMATIQUE / TYRE 5" SLICK OPTION

Manufacturier / <i>Manufacturer</i>	Reifenwerk Heidenau GmbH&Co.KG
Marque / <i>Make</i>	<b>MOJO</b>
Modèle / <i>Model</i>	<b>D2XX 4.5/10.0-5</b>
Catégorie / <i>Category</i>	Groups 1 & 2
Durée de l'homologation / <i>Validity of the homologation</i>	3 ans / 3 years
Nombre de pages / <i>Number of pages</i>	4
La présente Fiche d'Homologation reproduit descriptions, illustrations et dimensions du pneumatique au moment de l'homologation CIK-FIA et du test d'homologation.	<i>This Homologation Form reproduces descriptions, illustrations and dimensions of the tyre at the moment of the CIK-FIA homologation and of the homologation test.</i>
	
Photo du pneu monté sur la jante / <i>Photo of the tyre fitted to the rim</i>	Dessin de la bande de roulement / <i>Tread design drawing</i>
<b>SIGNATURE ET TAMPON DE L'ASN / SIGNATURE AND STAMP OF THE ASN</b>	<b>SIGNATURE ET TAMPON DE LA CIK-FIA / SIGNATURE AND STAMP OF THE CIK-FIA</b>
	

DESCRIPTIONS TECHNIQUES	TECHNICAL DESCRIPTIONS
Sous une température de 23°C +/-2°C, avec une humidité de 50% +/-5%	At a temperature of 23°C +/-2°C and with a humidity of 50% +/-5%

Pt	Descriptions / Descriptions	Valeurs / Values		Tolérances / Tolerances	
1	Dimensions / <i>Dimensions</i>	4.5/10.0-5		--	
2	Désignation du mélange / <i>Tread compound designation</i>	D2XX		--	
3	Pression de service / <i>Service pressure</i>	0.65 bar		+/- 0.3 bar	
4	Pression de gonflage / <i>Inflation pressure</i>	4.0 bar		max	
5	Capacité de charge / <i>Load capacity</i>	80 kg		max	
6	Vitesse maximale / <i>Maximum speed</i>	180 km/h			
7	Rigidité latérale et verticale (sous charge de 40 kg) / <i>Lateral and vertical stiffness (under 40 kg load)</i>	V: 1.0 mm L: 13.0 mm		L: +/-1 V: +/-2	
8					
9	Profondeur du profil / <i>Depth of tread</i>	3.5 mm		+/- 0.5 mm	
10	Poids en grammes / <i>Weight in grams</i>	1115		+/- 10%	
11	Nombre de plis / <i>Number of plies</i>	2		--	
12	Épaisseur de la bande de roulement / <i>Tread thickness</i>	4.5 mm		+/- 1.0 mm	
13	Nombre d'indicateurs d'usure du pneu / <i>Number of tread wear indicators</i>	8		--	
14	Matériau de la carcasse / <i>Carcass material</i>	Polyester		--	
15	Angle de tissage de la toile du pneu / <i>Angle of tyre canvas</i>	30°		+/- 3°	
16	Type de fil de tissage (selon ISO) / <i>Canvas thread type (according to ISO)</i>	1100		--	
17	Pneu tubeless / <i>Tubeless tyre</i>	Yes		--	
18	Dureté superficielle de la bande de roulement (ISO 48:1010 – 2 échantillons de 2 mm d'épaisseur) / <i>Superficial tread hardness (ISO 48:1010 – 2 samples of 2 mm thickness)</i>	53.0		+/- 5 DIDC - IRHD	
19	Contrainte-déformation en traction (ISO 37:2017 – éprouvette type 3) / <i>Tensile stress-strain (ISO 37:2017 – type 3 sample)</i>	à / at 100%	à / at 300%	à / at 100%	à / at 300%
		1.7	6.9	+/- 0.5 MPa	+/- 0.8 MPa

<b>DESSIN</b>	<b>DRAWING</b>
---------------	----------------

Dessin du pneu en section transversale et dimensions du pneu monté sur une jante / <i>Drawing of tyre cross section and dimensions of the tyre fitted to a rim</i>	Dimensions / <i>Dimensions</i>	Tolérances / <i>Tolerances</i>
	Ø 259 mm	+/- 5.0 mm
	Ø 126.2 *	+0/-1.0
	132 mm	+/- 3.0 mm
	80 mm	+/- 3.0 mm
	120 mm	+/- 2.0 mm
*Dimension selon Dessin Technique N° 1.1 - Jante 5" / Dimension according to Technical Drawing N° 1.1 - 5" rim		

DESSIN TECHNIQUE N° 1.1 / TECHNICAL DRAWING No. 1.1

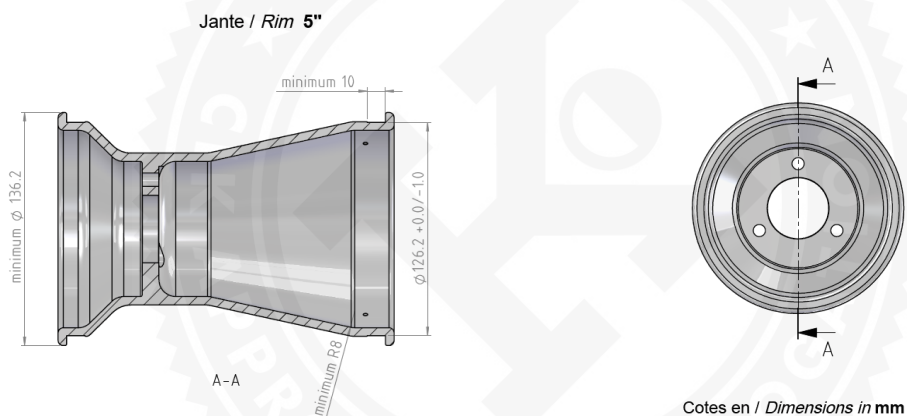

**PHOTOS ET INSCRIPTIONS****PHOTOS AND INSCRIPTIONS**

Pendant toute la période d'homologation, il est interdit d'apposer des inscriptions autres que celles mentionnées ci-dessous et appliquées lors de la production.

*Throughout the homologation period, it is forbidden to affix markings other than those mentioned below and applied at the time of production.*

Photo du flanc extérieur du pneu /  
*Photo of tyre external sidewall*

Inscriptions sur le flanc extérieur du pneu /  
*Inscriptions on tyre external sidewall*





Texte / Text	Hauteur / Height	Trait / Stroke
MOJO (printed)	11 mm	2.5 mm
4.5/10.0 – 5	7 mm	2.0 mm
TUBELESS	4 mm	0.5 mm
MADE IN GERMANY	3 mm	0.5 mm
	8 mm	
FOR RACING PURPOSE ONLY	4 mm	0.5 mm
MAX. INFLATION PRESSURE 4.0 BAR/ 58 PSI	4 mm	0.5 mm

Photo du flanc intérieur du pneu /  
*Photo of tyre internal sidewall*

Inscriptions sur le flanc intérieur du pneu /  
*Inscriptions on tyre internal sidewall*



Texte / Text	Hauteur / Height	Trait / Stroke
MOJO	16 mm	5.0 mm
4.5/10.0 – 5	7 mm	2.0 mm
TUBELESS	4 mm	0.5 mm
MADE IN GERMANY	3 mm	0.5 mm
D2XX	5 mm	0.5 mm
	8 mm	
FOR RACING PURPOSE ONLY	4 mm	0.5 mm
MAX. INFLATION PRESSURE 4.0BAR/ 58 PSI	4 mm	0.5 mm
CIK	6 mm	2.0 mm
Option	5 mm	0.5 mm